



DFS60B-TANK01024

DFS60

INCREMENTAL ENCODERS

SICK
Sensor Intelligence.



Illustration may differ



Ordering information

Type	Part no.
DFS60B-TANK01024	1094288

Other models and accessories → www.sick.com/DFS60

Detailed technical data

Performance

Periods per revolution	1,024
Measuring step	90° electronically/ppr
Measuring step deviation at binary number of lines	± 0.008°
Error limits	± 0.05°

Interfaces

Communication interface	Incremental
Communication Interface detail	Sin/Cos ¹⁾
Number of signal channels	6-channel
Initialization time	40 ms
Output frequency	≤ 200 kHz
Operating current	40 mA
Power consumption	≤ 0.5 W (without load)
Load resistance	≤ 120 Ω

¹⁾ 1.0 V_{SS} (differential).

Electrical data

Connection type	Cable, 8-wire, universal, 1.5 m ¹⁾
Supply voltage	4.5 ... 5.5 V
Reference signal, number	1
Reference signal, position	90°, electronically, gated with Sinus and Cosinus
Short-circuit protection of the outputs	✓ ²⁾
MTTFd: mean time to dangerous failure	300 years (EN ISO 13849-1) ³⁾

¹⁾ The universal cable connection is positioned so that it is possible to lay it without bends in a radial or axial direction.

²⁾ Short-circuit opposite to another channel, US or GND permissible for maximum 30 s.

³⁾ This product is a standard product and does not constitute a safety component as defined in the Machinery Directive. Calculation based on nominal load of components, average ambient temperature 40°C, frequency of use 8760 h/a. All electronic failures are considered hazardous. For more information, see document no. 8015532.

Mechanical data

Mechanical design	Through hollow shaft
Shaft diameter	6 mm
Weight	+ 0.2 kg
Shaft material	Stainless steel
Flange material	Aluminum
Housing material	Aluminum die cast
Start up torque	0.8 Ncm (+20 °C)
Operating torque	0.6 Ncm (+20 °C)
Permissible shaft movement, axial static/dynamic	± 0.5 mm / ± 0.2 mm
Permissible shaft movement, radial static/dynamic	± 0.3 mm / ± 0.1 mm
Operating speed	≤ 6,000 min ⁻¹ ¹⁾
Moment of inertia of the rotor	40 gcm ²
Bearing lifetime	3.6 x 10 ¹⁰ revolutions
Angular acceleration	≤ 500,000 rad/s ²

¹⁾ Allow for self-heating of 3.3 K per 1,000 rpm when designing the operating temperature range.

Ambient data

EMC	According to EN 61000-6-2 and EN 61000-6-3
Enclosure rating	IP65, housing side, cable connection (according to IEC 60529) IP65, shaft side (according to IEC 60529)
Permissible relative humidity	90 % (condensation of the optical scanning not permitted)
Operating temperature range	-40 °C ... +100 °C ¹⁾ -30 °C ... +100 °C ²⁾
Storage temperature range	-40 °C ... +100 °C, without package
Resistance to shocks	70 g, 6 ms (according to EN 60068-2-27)
Resistance to vibration	30 g, 10 Hz ... 2,000 Hz (according to EN 60068-2-6)

¹⁾ Stationary position of the cable.

²⁾ Flexible position of the cable.

Classifications

ECl@ss 5.0	27270501
ECl@ss 5.1.4	27270501
ECl@ss 6.0	27270590
ECl@ss 6.2	27270590
ECl@ss 7.0	27270501
ECl@ss 8.0	27270501
ECl@ss 8.1	27270501
ECl@ss 9.0	27270501
ECl@ss 10.0	27270501
ECl@ss 11.0	27270501
ETIM 5.0	EC001486

ETIM 6.0	EC001486
ETIM 7.0	EC001486
UNSPSC 16.0901	41112113

Dimensional drawing (Dimensions in mm (inch))

Through hollow shaft, cable connection

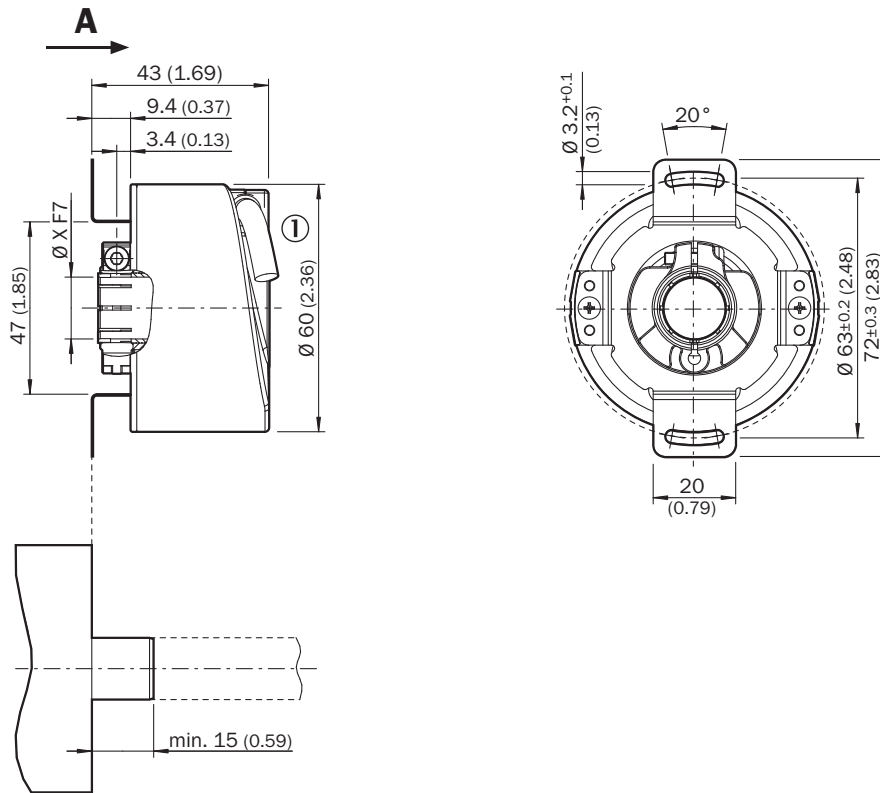

General tolerances according to DIN ISO 2768-mk

① Cable diameter = 5.6 mm +/- 0.2 mm bend radius = 30 mm

Type Through hollow shaft	Shaft diameter XF7	Shaft diameter xj7
DFS60x-TAxxxxxxx	6 mm	Provided by customer
DFS60x-TBxxxxxxx	8 mm	
DFS60x-TCxxxxxxx	3/8"	
DFS60x-TDxxxxxxx	10 mm	
DFS60x-TExxxxxxx	12 mm	
DFS60x-TFxxxxxxx	1/2"	
DFS60x-TGxxxxxxx	14 mm	
DFS60x-THxxxxxxx	15 mm	
DFS60x-TJxxxxxxx	5/8"	

PIN assignment

Cable, 8-wire

View of M12 male device connector on encoder



View of M23 male device connector on encoder



PIN, 8-pin, M12 male connector	PIN, 12-pin, M23 male connector	Color of the wires for encoders with cable outlet	TTL/HTL signal	Sin/cos 1.0 V _{ss}	Explanation
1	6	Brown	\bar{A}	COS-	Signal wire
2	5	White	A	COS+	Signal wire
3	1	Black	\bar{B}	SIN-	Signal wire
4	8	Pink	B	SIN+	Signal wire
5	4	Yellow	\bar{Z}	\bar{Z}	Signal wire
6	3	Violet	Z	Z	Signal wire
7	10	Blue	GND	GND	Ground connection of the encoder
8	12	Red	+U _s	+U _s	Supply voltage (volt-free to housing)
-	9	-	n.c.	n.c.	Not assigned
-	2	-	n.c.	n.c.	Not assigned
-	11	-	n.c.	n.c.	Not assigned
-	7 ¹⁾	-	0-SET ¹⁾	n.c.	Set zero pulse ¹⁾
Screen	Screen	Screen	Screen	Screen	Screen connected to housing on encoder side. Connected to ground on control side.

¹⁾ For electrical interfaces only: M, U, V, W with 0-SET function on PIN 7 on M23 male connector. The 0-SET input is used to set the zero pulse on the current shaft position. If the 0-SET input is connected to U_s for longer than 250 ms after it had previously been unassigned for at least 1,000 ms or had been connected to the GND, the current position of the shaft is assigned to the zero pulse signal "Z".

Maximum revolution range

Maximum revolution range



Signal outputs

Signal outputs









CW with view on the encoder shaft in direction "A", compare dimensional drawing.

Supply voltage	Output
4,5 V ... 5,5 V	TTL
10 V ... 32 V	TTL
10 V ... 32 V	HTL

Recommended accessories

Other models and accessories → www.sick.com/DFS60

	Brief description	Type	Part no.
Flanges			
	Standard stator coupling	BEF-DS00XFX	2056812
Other mounting accessories			
	Clamping ring for metal hollow shaft, metal	BEF-KR-M	2064709
Plug connectors and cables			
	Head A: female connector, JST, 8-pin, straight Head B: Flying leads Cable: Incremental, SSI, PUR, halogen-free, shielded, 5 m	DOL-0J08-G05MAA3	2046876
	Head A: female connector, JST, 8-pin, straight Head B: Flying leads Cable: Incremental, SSI, PUR, halogen-free, shielded, 0.5 m	DOL-0J08-G0M5AA3	2046873
	Head A: female connector, JST, 8-pin, straight Head B: Flying leads Cable: Incremental, SSI, PUR, halogen-free, shielded, 10 m	DOL-0J08-G10MAA3	2046877
	Head A: female connector, JST, 8-pin, straight Head B: Flying leads Cable: SSI, Incremental, PUR, halogen-free, shielded, 1.5 m	DOL-0J08-G1M5AA6	2048590
	Head A: female connector, JST, 8-pin, straight Head B: Flying leads Cable: SSI, Incremental, PUR, halogen-free, shielded, 3 m	DOL-0J08-G3M0AA6	2048591
		Head A: female connector, JST, 8-pin, straight Head B: male connector, M23, 12-pin, straight Cable: Incremental, PUR, halogen-free, shielded, 1 m	STL-2312-G01MAA3
Head A: female connector, JST, 8-pin, straight Head B: male connector, M23, 12-pin, straight Cable: Incremental, PUR, halogen-free, shielded, 2 m		STL-2312-G02MAA3	2061504
Head A: female connector, JST, 8-pin, straight Head B: male connector, M23, 12-pin, straight Cable: Incremental, PUR, halogen-free, shielded, 0.35 m		STL-2312-GM35AA3	2061621
	Head A: male connector, M12, 8-pin, straight, A-coded Head B: - Cable: Incremental, shielded	STE-1208-GA01	6044892
		Head A: male connector, M23, 12-pin, straight Head B: - Cable: HIPERFACE®, SSI, Incremental, shielded	STE-2312-G01
			STE-2312-GX

SICK AT A GLANCE

SICK is one of the leading manufacturers of intelligent sensors and sensor solutions for industrial applications. A unique range of products and services creates the perfect basis for controlling processes securely and efficiently, protecting individuals from accidents and preventing damage to the environment.

We have extensive experience in a wide range of industries and understand their processes and requirements. With intelligent sensors, we can deliver exactly what our customers need. In application centers in Europe, Asia and North America, system solutions are tested and optimized in accordance with customer specifications. All this makes us a reliable supplier and development partner.

Comprehensive services complete our offering: SICK LifeTime Services provide support throughout the machine life cycle and ensure safety and productivity.

For us, that is “Sensor Intelligence.”

WORLDWIDE PRESENCE:

Contacts and other locations –www.sick.com